



# flexitron group



## VERTICAL SOLUTIONS

# 1. INDEX

1. Index	P. 2
2. Let's Make a Smart World	P. 3
3. MTX Connectivity Solutions	P. 4
4. Cervello IoT Platform	P. 5
5. Smart Grid & Metering	P. 7
6. Smart Parking	P. 12
7. Waste Management	P. 17
8. Smart Lighting	P. 21
9. Environment & Air Quality	P. 23
10. Smart Transportation	P. 25
11. Smart City with Cervello & MTX	P. 27

## 2. LET'S MAKE A SMART WORLD

The planet becomes more urbanized and cities need to become smarter. Cities with high population density have increased effects on the weather, transportation, water levels, building management and public spaces. We find ourselves needing smart solutions for the issues at hand, solutions that are both highly efficient and sustainable, as well as financially viable in order to create social wellbeing.

There are many definitions of Smart City. From our point of view cities are systems of systems, and every day there are new opportunities to introduce new digital nervous systems, intelligent responsiveness, and optimization at every level of system integration.

One of the challenges of a Smart City is the safety of the citizens. For that use, 3G/4G/LTE connectivity applied to IoT applications, allows for real time control of all kinds of alarms (for example fire or smoke alarms), which makes it possible to send a signal to the central offices as soon as the alarm is activated.

The real “smartness” of a ‘Smart City’ lies in using IoT/M2M communications in a standardised, secure, accountable and harmonised way to fulfil the dreams and aspirations of its citizens.



### 3. MTX CONNECTIVITY SOLUTIONS

MTX is the brand of Matrix Electronica dedicated to design and manufacture industrial modems, routers and gateways for wireless communications based on cellular networks (4G-LTE / 3G-HSPA-UMTS / 2G-EGPRS / GSM) and other wired connections (RS232, RS485, Ethernet, USB, I2C) as well as short-range wireless communications (LoRa, BlueTooth, Wi-Fi, Wireless M-Bus or RF ISM bands).

MTX has a complete range of solutions and applications for IoT and M2m. We provide wireless terminals (Modems, Routers and Gateways) and embedded software that allows their use in both industrial and user-oriented markets. The multiple possibilities of MTX terminals allow them to adapt to any connectivity needs.



Alarms & Security



Metering



Fleet Control



Remote Control

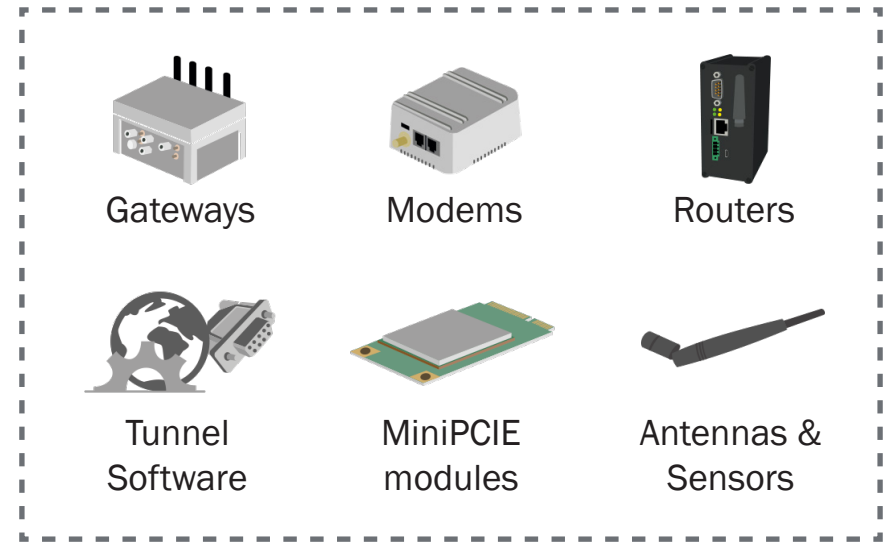

There are an infinite number of possible applications.

## 4. CERVELLO IOT PLATFORM

Developed by IoTBlue, Cervello is a multitenant cloud platform that allows you to connect any IoT device to a web platform for easy control and management.

This platform is a Software as a Service (SaaS) cloud solution intended to remotely manage and monitor IoT and M2M devices with infinite possibilities: gathering big data, remote control, traffic management, metering, etc.

Cervello allows for an easy integration, and makes managing infrastructures easy, allowing the user to focus on their business. That way, without the need of a development team of your own, costs and risks are reduced, as well as time to market. It also can be escalated as the business grows, and pay only for what is used.



The following example illustrates how Cervello functions in a smart city, where the platform controls and measures several devices through modems connected to Cervello Device Manager, which receives sensor data in real time, and is able to control said devices remotely, control the traffic, etc.

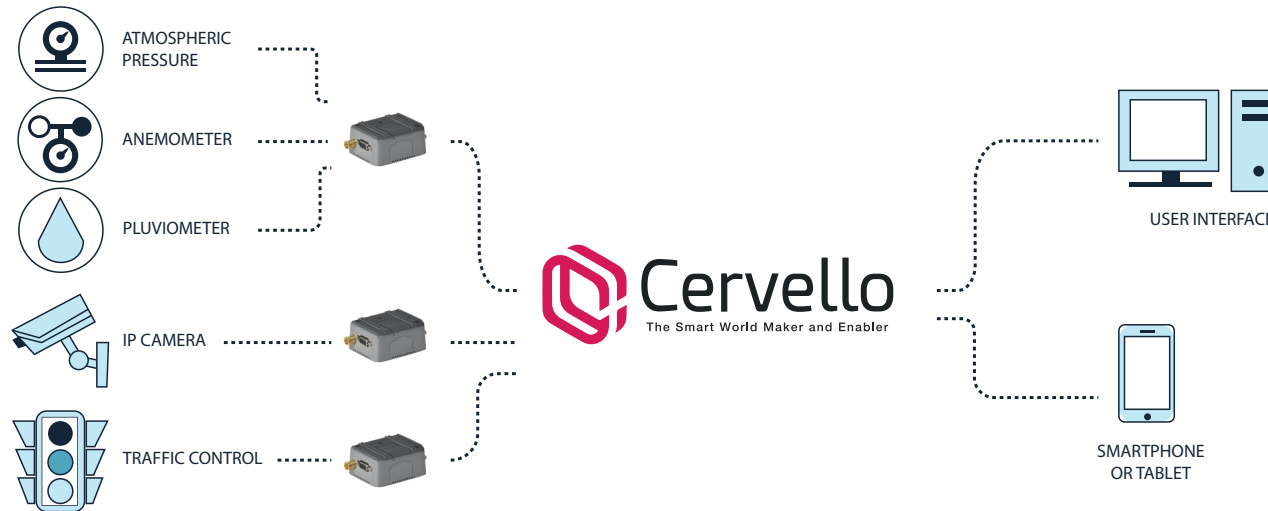

## 4. CERVELLO FEATURES



### Visualizing and analyzing data

Providing completely configurable widgets. Line graphics, digital and analog meters, maps and much more incorporated. Creating dashboards and sharing it with customers.



### Remote control

Controlling devices remotely through the dashboard or API. Sending RPC commands to devices and viceversa.



### IoT gateway

Integrating devices connected to installed systems using existent protocols. Connecting to OPC-UA or MQTT broker in minutes.



### Device management

Providing the ability to register and manage devices. Allowing to control on customer's side and to provide server device attributes.



### Multitenant

A user can have several administrators as well as millions of customers and devices.



### Horizontal scalability

The applications amount and server supported devices increases linearly as new Cervello servers are added. There is no inactivity time, the server does not restart nor do application errors pop up.



### Fault tolerant

All Cervello servers are identical. There are no master or waiting servers. Node fault is automatically detected. Fault nodes can be replaced without inactivity time. Persistent data are replicated using a high availability NoSQL data base.



### Personalisation and integration

Increasing the functionality of the predetermined platform through customizable implementations, widgets and transport. As well as MQTT, CoAP and HTTP support, Cervello users can use their own transport implementations or personalise the behaviour of existing protocols.

## 5. SMART GRID & METERING

The goal of Smart Grid and Metering is the improvement of the citizens' quality of life by a more efficient use of the resources at hand when it comes to metering different power resources such as electricity, water, gas, etc. A more detailed account of each example is given in the following pages.

Some of the benefits of Smart Metering are:

- Real time metering: the MTX-Java-T modems have the ability to read metering boxes in real time via RS232/RS485.
  - Real time transmission: the MTX-Java-T modems can simultaneously send the read data via 4G/3G/2G or GSM connectivity.
  - Remote control: MTX-Java-T modems along the Cervello Device Manager allows for the remote control
  - Immediate troubleshooting: to attend immediately any inappropriate use of the resources or system failure.
  - Efficiency: the ability of immediate troubleshooting allows for a more efficient management of the equipment.
  - Saving power: the result of being able to troubleshoot a system failure immediately will result in power/resources saving.
  - Saving transportation: the ability to troubleshoot remotely will result in saving transportation costs.
  - Saving time: the ability to troubleshoot remotely will also result in saving time, which will allow for a more efficient use of the equipment, and also a more efficient use of the maintenance team's time.
- Anticipation: the ability of the Cervello Device Manager to organize and interpret gathered data will allow us to figure out consumer trends and anticipate future bills.
  - Precision: having access to all this information in real time will allow for a more precise decision-making process while managing the system.
  - Ultimately, the saving and more efficient use of power resources will result in a more sustainable solution and less impact on the environment, which will improve the citizens' quality of life.

## 5. SMART GRID & METERING - ELECTRICITY

The following example shows two possible scenarios.

A basic scenario involves a meter box that connects with an MTX-GTW gateway via wired M-Bus RS485 or wireless LoRa/WM-Bus/RF ISM Bands/WiFi. At the same time, the MTX-GTW connects on one hand with Cervello Device Manager via 3G/4G as Cervello connects with the central offices via Internet, and on the other hand with the electricity operator via GSM. That way, from the offices we can have access to real time metering readings. When the electricity operator makes its daily call, it gives priority to the GSM call and stops the connection with the offices, until the call ends, and the connection is restored.

The advanced scenario involves a PLC device, in case there is no connection with the offices nor with the electricity operator. The device acts like a transparent serial gateway, sending the data directly to the PLC and viceversa via RS232/RS485. As soon as a connection is made with the offices, the gateway connection with the PLC is interrupted. Same applies when a GSM call is made from the electricity operator, until connection with the PLC is restored.

### RECOMMENDED PRODUCTS

- MTX-GTW: Compact Linux Java WiFi Ethernet Gateway
- CERVELLO: IoT Platform

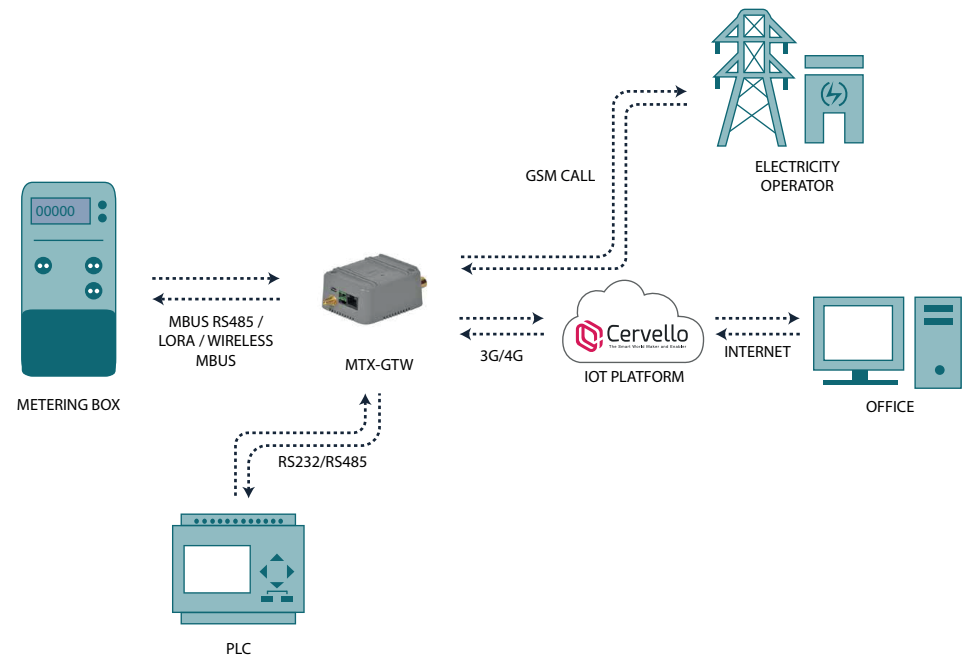



## 5. SMART GRID & METERING - WATER

The following example shows how to develop a system of smart communications to control water supply networks, that will gather data from metering boxes, store it and send it to the server for its processing in a remote data analysis and management platform. This system should guaranty the needs of most of the water operator companies in the sector.

On the diagram we see an MTX-GTW gateway with SigFox/LoRaWan/WM-Bus/RF ISM Bands/WiFi and NB IoT/LTE connected to metering boxes, industrial metering boxes or motorized valves via wired M-Bus RS485 or wireless LoRa/WM-Bus/RF ISM Bands/WiFi. The MTX device reads the meter boxes in real time, and sends the data to Cervello Device Manager via 3G/4G.

Cervello is accessed from the office facilities via internet, and is responsible for managing, analysing and processing the data. In case of being unable to connect he devices to a power source, they can be powered by 10-year batteries (the life of a water metering box). In order to do this, the equipment should be able to enter ultra low power mode while it is not receiving/sending data.

### RECOMMENDED PRODUCTS

- MTX-GTW: Compact Linux Java WiFi Ethernet Gateway
- CERVELLO: IoT Platform

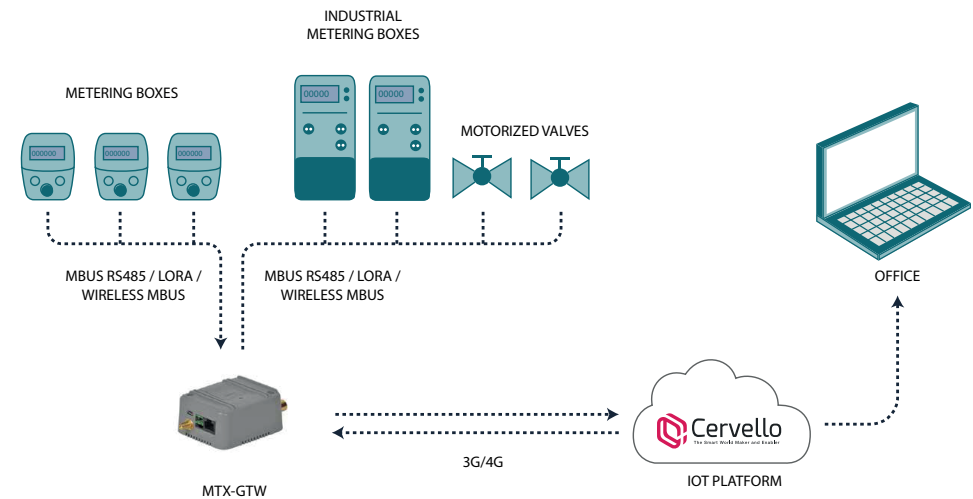

## 5. SMART GRID & METERING - GAS

The following example shows a gas metering solution, that will resemble the water metering one:

On one side we will have the metering boxes, connected to an MTX-GTW device via wired M-Bus RS485 or wireless LoRa/WM-Bus/RF ISM Bands/WiFi, sending data to Cervello Device Manager via 3G/4G.

On the other side, we will be able to access processed data on Cervello from the central offices via Internet.

### RECOMMENDED PRODUCTS

- MTX-GTW: Compact Linux Java WiFi Ethernet Gateway
- CERVELLO: IoT Platform

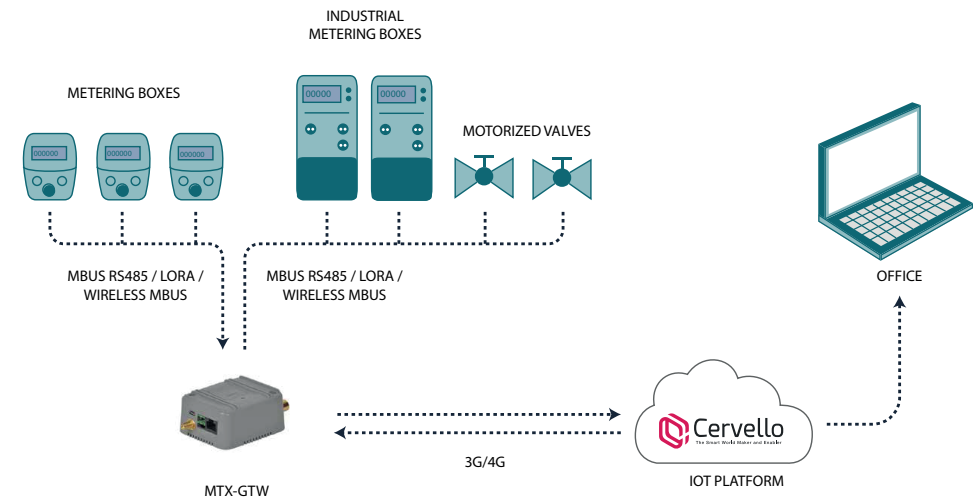

## 5. SMART GRID & METERING - EQUIPMENT



### MTX-GTW

*Compact Linux Java WiFi Ethernet Gateway*

The MTX-GTW is a small device with Embedded Linux. It's an innovative and flexible device with a powerful ARM processor and a wide range of interfaces including Ethernet, WiFi, RS485, Wireless M-Bus, LoRa/WM-Bus/RF ISM Bands/WiFi, RS232, CAN, USB OTG, GPIO.

### MECHANICAL SPECIFICATIONS

DC INPUT: 24V (7 a 50VDC)

- TEMPERATURE RANGE: -40°C a +85°C
- DIMENSIONS: 78.1 x 66.8 x 37.2mm
- WEIGHT: 160gr

### PROCESSOR

- Freescale (ARM9 architecture)

- 454MHz clock CPU freq
- 128MB DDR2
- 4GB eMMC Flash
- 32KB EEPROM
- Linux kernel 3.14
- Java VM loaded

### INTERFACES

- Ethernet 10/100 BaseT (RJ45 connector)
- USB and DB15 HD female connector (\*): RS232/485/422, CAN
- 2.0, 1-wire, latch relay, count I, optoisolated I/Os, analog I/O
- Optional LoRa/WM-Bus/RF ISM Bands/WiFi module
- 2 operating LEDs
- SIM card interface 1.8V/3V
- Optional GPS receiver
- Optional WiFi b/g/n with external antenna
- Optional gyroscope + magnetometer
- Optional 3-axis accelerometer

## 6. SMART PARKING

Parking in any city center can be challenging. The aim of Smart Parking is to optimize the urban space and facilitating the parking experience both outdoors and indoors. A more detailed account of each example is given in the following pages.

Some of the benefits of Smart Parking are:

- Optimizing urban space: as drivers access an app informing them about available parking spaces, urban space can be made the most of.
- Improving drivers' parking experience: by reducing the common frustration of extended parking searches.
- Reducing pollution: by reducing the time of parking searches.
- Reducing traffic: by reducing the time of parking searches.
- Automating and facilitating payment: via an online app connected to Cervello Device Manager.
- Saving in personnel: since payment can be done through the online app.
- Optimizing staff's time: by reducing his customer management.
- Saving resources and money for the company: due to staff reduction and customers' self-service ability.
- Enhancing security at parking spaces: thanks to the possibility of installing a security camera.

## 6. SMART PARKING - OUTDOOR

The following example shows an MTX-Router-Titan device connected via LoRa/Wi-Fi/RF ISM Bands/WiFi to several sensors installed on each parking space. The router will also be connected to Cervello Device Platform via 3G/4G, which will make it possible to manage the received data from the central offices, connected to Cervello via Internet. MTX-Router-Titan, with an autonomous software, will also be connected to information panels installed around the parking space to inform users of the general state of parking spots: how many available spots on each parking floor, etc. Another functionality will be a mobile application users can download to check information on parking spaces, make payments, etc., information that will be retrieved from Cervello via Internet.

The MTX-Router-Titan also has the capability to connect to a camera via Ethernet, which will send video information to Cervello and can be used as a security enhancement.

### RECOMMENDED PRODUCTS

- MTX-ROUTER-TITAN: Advanced 4G Router with Ethernet
- CERVELLO: IoT Platform

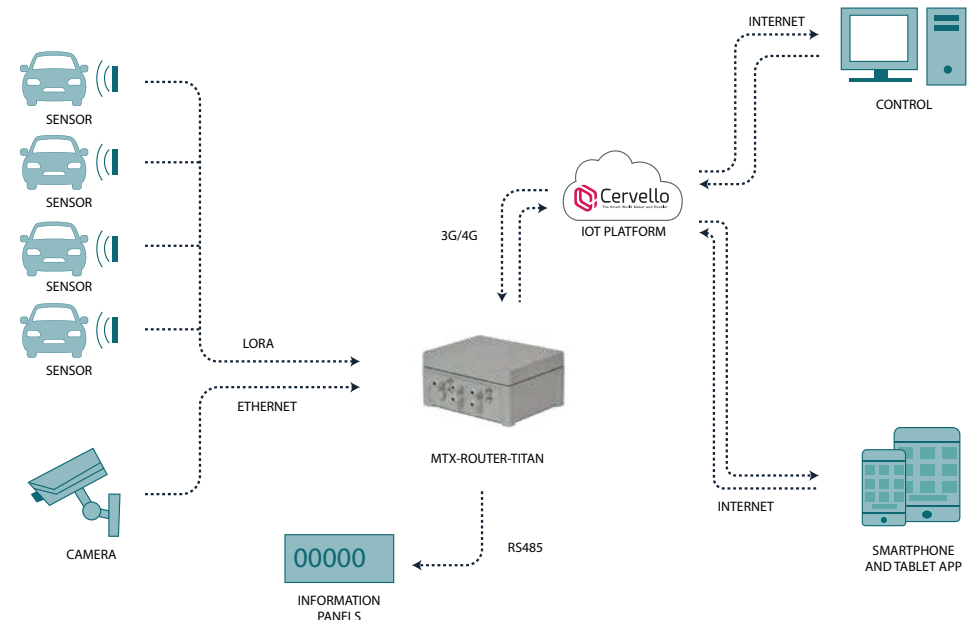

## 6. SMART PARKING - INDOOR

The following example shows an MTX-Router-Titan device connected via RS485 to several sensors installed over each parking space. The router will also be connected to Cervello Device Platform via 3G/4G, which will make it possible to manage the received data from the central offices, connected to Cervello via Internet. MTX-Router-Titan, with an autonomous software, will also be connected to information panels installed around the parking space to inform users of the general state of parking spots: how many available spots on each parking floor, etc. Another functionality will be a mobile application users can download to check information on parking spaces, make payments, etc., information that will be retrieved from Cervello via Internet.

The MTX-Router-Titan also has the capability to connect to a camera via Ethernet, which will send video information to Cervello and can be used as a security enhancement.

### RECOMMENDED PRODUCTS

- MTX-ROUTER-TITAN: Advanced 4G Router with Ethernet
- CERVELLO: IoT Platform

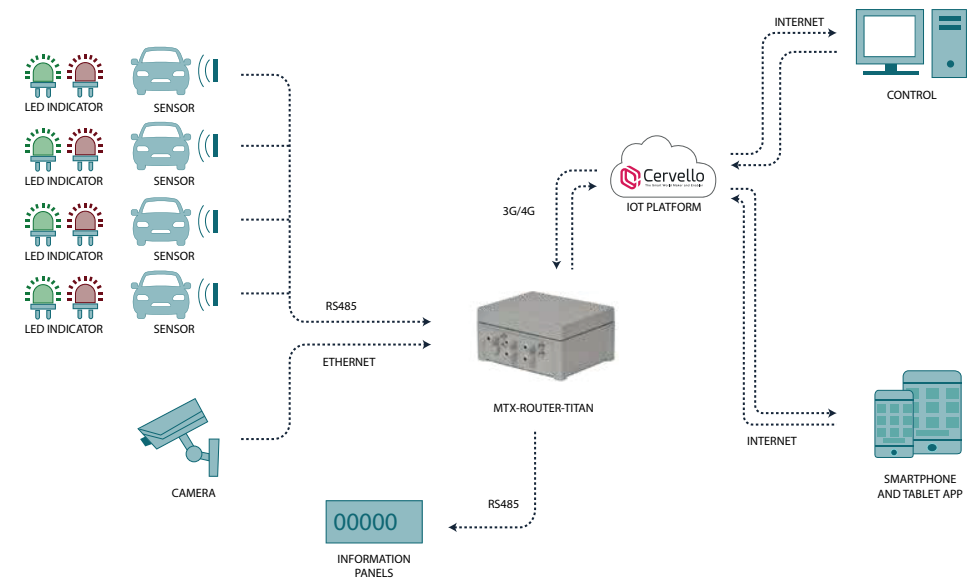

## 6. SMART PARKING - CAMERAS

The following example shows an MTX-Router-Titan device connected to several IP cameras via Ethernet or 3G/4G, each covering several parking spots. All that video data is sent to Cervello Device Manager via 3G/4G, and it is accessible from the central offices that connect to Cervello via Internet. The router can also send data via RS485 to information panels around the parking, since it has an autonomous operative system.

Cervello can also send relevant information to a user app from where the users can look for parking, make reservations, and pay online via Internet.

This solution is more economical than ground-based sensors.

### RECOMMENDED PRODUCTS

- **MTX-ROUTER-TITAN:** Advanced 4G Router with Ethernet
- **CERVELLO:** IoT Platform

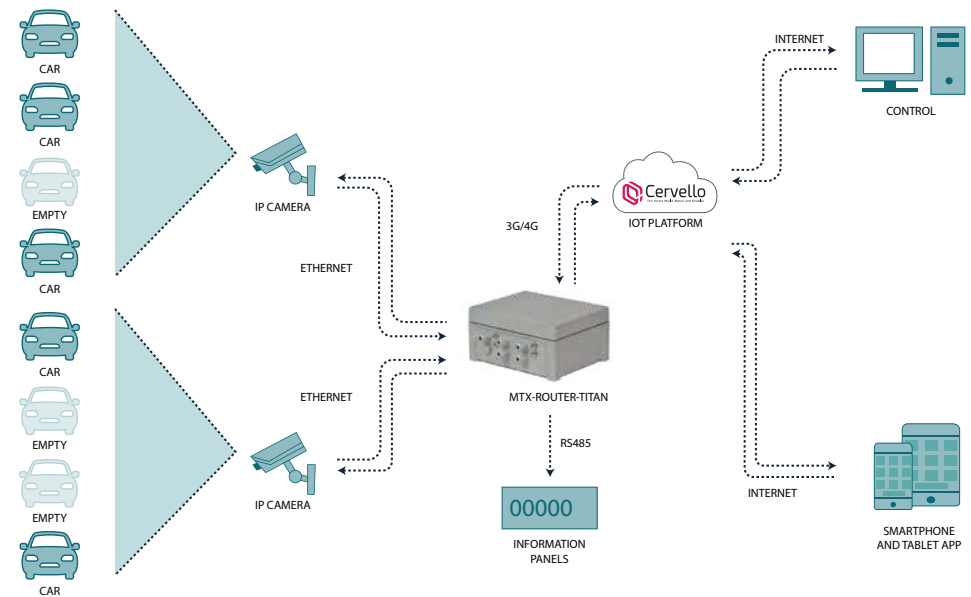

## 6. SMART PARKING - EQUIPMENT



### MTX ROUTER TITAN

*Industrial Outdoor Router with GSM/GPRS/3G/4G and RF options*

The MTX-Router-Titan is an innovative and powerful industrial router with a complete set of wired and wireless interfaces, all managed by an ARM9 processor with embedded Linux.

### MECHANICAL SPECIFICATIONS

- DC: 24V (7-50 Vdc) | AC: 90-264V (120-370 Vdc)
- TEMPERATURE RANGE: -40°C a +85°C
- DIMENSIONS: 201x163x98mm
- WEIGHT: <500gr

### INTERFACES

- IP65 enclosure
- Ethernet 10/100 BaseT (RJ45 connector)
- USB 2.0 (micro AB), RS232 2-wire and 4-wire, RS485

- Digital input
- Optional LoRa/WM-Bus/RF ISM Bands/WiFi module
- 2 operating LEDs
- SIM card interface 1.8V/3V
- Out 3.3V, 5V, 24V
- Relay with plug-in type terminal blocks: 2x 8A/250VAC relays
- WiFi 802.11 b/g/n
- Optional GPS module



## 7. WASTE MANAGEMENT

An efficient waste management system is essential to any Smart City that wants to improve the quality of life of its citizens by creating cleaner urban spaces and a more sustainable system by saving precious resources. In order to do that, we would need an innovative and effective solution using the latest technologies and connectivity options.

An adequate management of waste residues would involve waste containers management on one hand, and on the other an efficient fleet control. A more detailed account of each example is given in the following pages.

Some of the benefits of Smart Waste Management are:

- Real time metering, thanks to the MTX-Router-Titan ability to receive data in real time with LoRa/WM-Bus/RF ISM Bands/WiFi technology.
  - Real time transmission, thanks to the MTX-Router-Titan ability to send data in real time via 4G/LTE connectivity.
  - Efficiency in waste pick-up, avoiding the need of driving to the location of every container, since the driver can check the levels from an app.
  - Reducing error margin by automating data managing with RFID readers and tags, which measure the waste amount, the date and time each container is emptied and identifies each waste container with a unique ID creating an inventory
- of all the containers.
- Improving the job of truck drivers who can access information in real time and use their time more effectively.
  - Saving transportation, resulting from the ability to access information remotely.
  - Saving time, resulting from the ability to access information remotely as well.
  - Saving resources for the management company, resulting from saving in transportation and time.
  - MTX-Router-Titan, being a powerful and complete device able to receive data from multiple sensors in real time via LoRa/WM-Bus/RF ISM Bands/WiFi technology, and also to supply WiFi connectivity and GPS information via 4G/LTE.
  - Improving the cleanliness of waste container locations, avoiding the overflowing of waste.
  - Less impact on the environment, resulting from the savings in transportation and cleaner cities.

# 7. WASTE MANAGEMENT - WASTE CONTAINERS

Two options for an efficient waste container management.

The first shows an MTX-Router-Titan connected via LoRa/WM-Bus/RF ISM Bands/WiFi to several sensors installed on waste containers. The router will also be connected with Cervello Device Manager via 3G/4G, so the data can be processed and then accessed from the offices facilities via Internet. Cervello will also feed data (via Internet too) to an app for truck drivers.

## RECOMMENDED PRODUCTS

- MTX-ROUTER-TITAN: Advanced 4G Router with Ethernet
- CERVELLO: IoT Platform

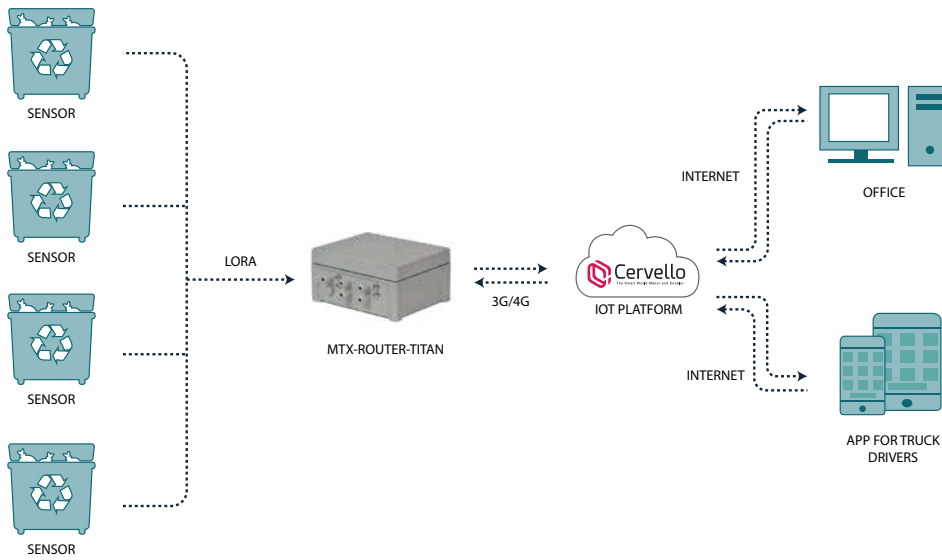

The second option is without a router. The data can be processed and accessed from the offices facilities via Internet when it is sent from the sensors. Cervello will also feed data (via Internet too) to an app that for truck drivers. The disadvantage of this option is the inability to have a wired connection with Cervello Device Manager.

## RECOMMENDED PRODUCTS

- MTX-ROUTER-TITAN: Advanced 4G Router with Ethernet
- CERVELLO: IoT Platform

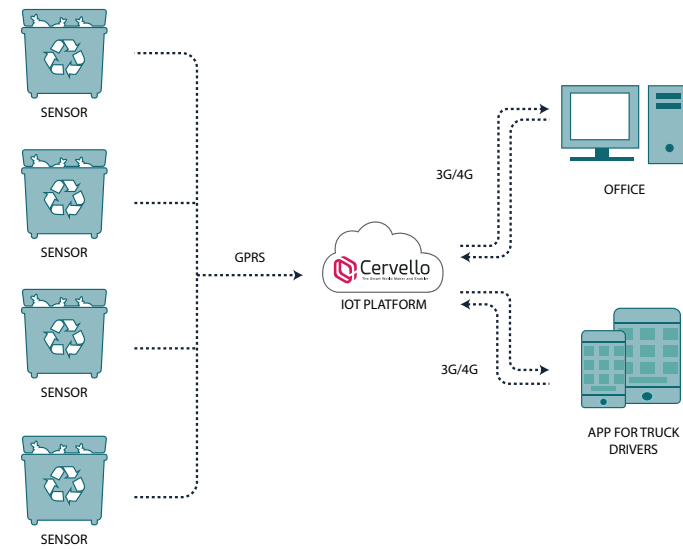

# 7. WASTE MANAGEMENT - FLEET CONTROL

The following example shows MTX-Router-Titan devices installed on waste management trucks. They will provide WiFi connection to access information regarding waste containers, location, etc., as well as supplying Internet connectivity for third party equipments. The router also has an internal GPS that will facilitate the location of each truck in real time, to improve coordination and waste management efforts. At the same time, the MTX-Router-Titan will be connected via RS485 to a sensor installed in each truck, that will send information about the capacity status of the truck to Cervello Device Manager via 3G/4G connectivity.

Cervello will gather all the data so it can be accessed from the central offices via IP connection. That information will also be available from an app (IP connection) for drivers to be aware of the waste management status in real time.

## RECOMMENDED PRODUCTS

- MTX-ROUTER-TITAN: Advanced 4G Router with Ethernet
- CERVELLO: IoT Platform

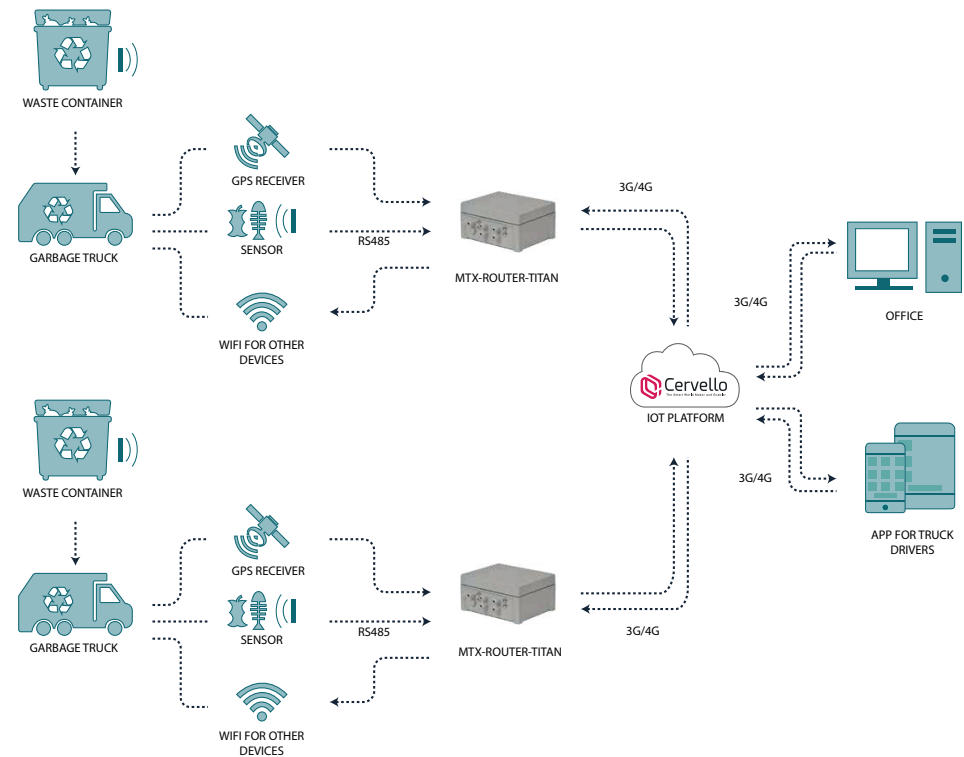

## 7. WASTE MANAGEMENT - EQUIPMENT



### MTX ROUTER TITAN

*Industrial Outdoor Router with GSM/GPRS/3G/4G and RF options*

The MTX-Router-Titan is an innovative and powerful industrial router with a complete set of wired and wireless interfaces, all managed by an ARM9 processor with embedded Linux.

### MECHANICAL SPECIFICATIONS

- DC: 24V (7-50 Vdc) | AC: 90-264V (120-370 Vdc)
- TEMPERATURE RANGE: -40°C a +85°C
- DIMENSIONS: 201x163x98mm
- WEIGHT: <500gr

### INTERFACES

- IP65 enclosure
- Ethernet 10/100 BaseT (RJ45 connector)
- USB 2.0 (micro AB), RS232 2-wire and 4-wire, RS485

- Digital input
- Optional LoRa/WM-Bus/RF ISM Bands/WiFi module
- 2 operating LEDs
- SIM card interface 1.8V/3V
- Out 3.3V, 5V, 24V
- Relay with plug-in type terminal blocks: 2x 8A/250VAC relays
- WiFi 802.11 b/g/n
- Optional GPS module

## 8. SMART LIGHTING

An efficient lighting system is key to any Smart City. The following example shows several MTX-Router-Titan II installed in smart poles every several street lights. Apart from providing WiFi to the whole area, they also provide LoRa/WiM-Bus/RF ISM Bands/WiFi to every street light within their reach. Each street light will have a smart receptor, receiving orders from the smart pole. Once you have connectivity, you can use it for other functions: you can install parking cameras, air quality sensors, fire alarms, and many kind of devices that can send useful information to the central offices via router and Cervello.

The devices will connect to Cervello via 4G/3G. Data can be accessed from the central offices via 4G/3G.

Some of the benefits of Smart Lighting are:

- Real time gathering and transmission of data.
- Real time information about possible malfunctions.
- Saving time and resources in light maintenance.
- Automated lighting thanks to LoRa/WiM-Bus/RF ISM Bands/WiFi provided by the MTX-Router-Titan II.
- Saving time and resources in light management.
- Positive impact on the environment thanks to saving and reduction of pollution thanks to a smarter management.
- Improving quality of life of citizens with better illumination.
- Improving security of the city by avoiding poorly lit areas.

### RECOMMENDED PRODUCTS

- MTX-ROUTER-TITAN II: Advanced Router
- CERVELLO: IoT Platform

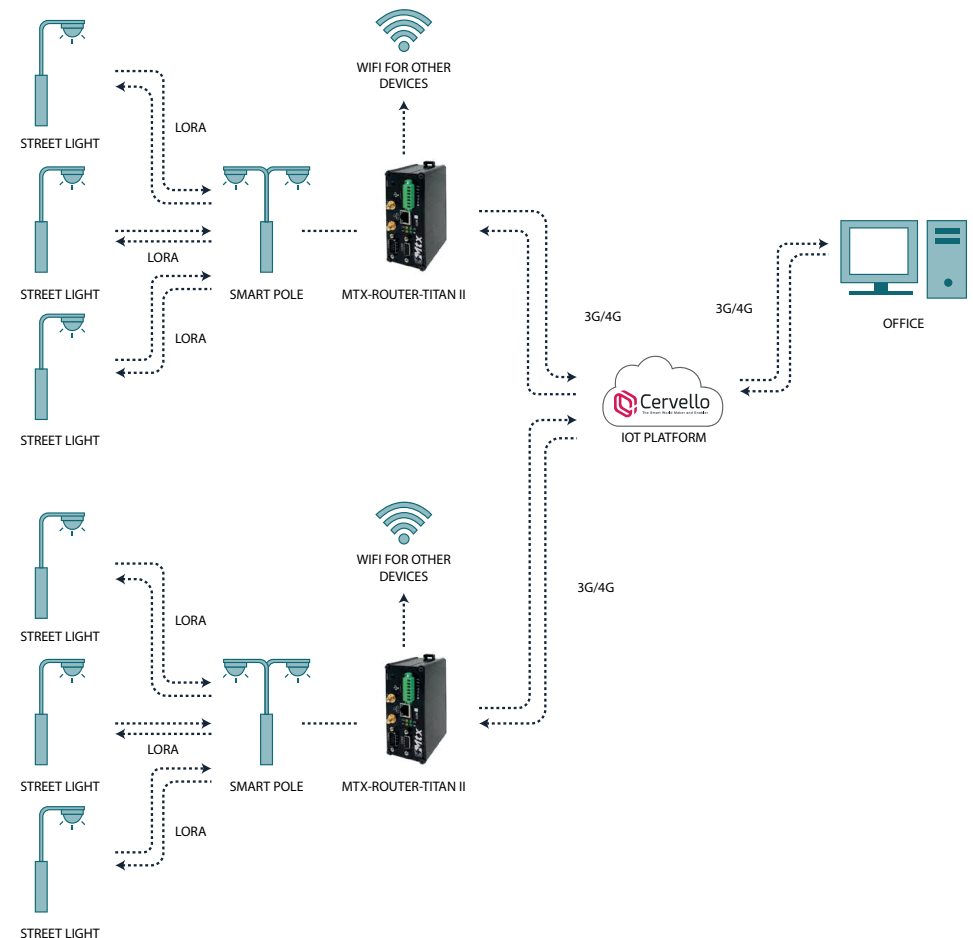

## 8. SMART LIGHTING - EQUIPMENT



### MTX-ROUTER-TITAN II

*LTE/4G/3G/GSM/GPRS Industrial Router*

The MTX-Router-Titan II is an innovative industrial router that comprises a complete set of wireless and wired interfaces powered by an ARM Cortex-A7 processor module. By providing an easy integration and powerful interfaces, it avoids further hardware components.

### MECHANICAL SPECIFICATIONS

- DC INPUT: 24V (8 a 30VDC)
- TEMPERATURE RANGE: -40°C a +85°C
- DIMENSIONS: 112x51x75mm
- WEIGHT: 500g

### OPTIONAL FEATURES

- External sensors: temp, distance, Modbus RTU/TCP device

- RF LoRa/WM-Bus/RF ISM Bands/WiFi/Wavenis module
- GPS module

### INTERFACES

- Ethernet 10/100 BaseT (RJ45 connector)
- USB 2.0 (micro AB connector), RS232 DB9M connectors, RS485 terminal block
- 4x operating LEDs
- Micro SIM card interface 1.8V/3V
- Power supply (2-way plug-in terminal block)
- SMA F radio connectors, RTC, 2x opto I
- WiFi 802.11 b/g/n (only commercial temperature range)

# 9. ENVIRONMENT & AIR QUALITY

Pollution has a direct effect on people’s health, which causes problems ranging from a decrease in quality of life, to an economic strain on healthcare systems. Investment in an efficient air quality management system can help avoid these ills and quantitatively improve the life of the citizens.

The following example shows several MTX-4G-Java-IoT, each connected via RS485 to several sensors in different areas around the city: air quality sensors, temperature sensors and humidity sensors. The information the sensors send to Cervello Device Manager through the modem (3G/4G) will help to determine the quality of the air, the CO2 levels, the location of pollution concentration hotspots, etc., which is very useful to make traffic restrictions and take other decisions that can help improve the environment quality.

This information can be accessed from the offices, and can also be sent to information panels around the city to inform citizens about traffic restrictions and raise environmental awareness.

Some of the benefits of environmental management are:

- Real time metering and transmission.
- Real time delivery of information to the public.
- Precision: real time information will allow for a more precise decision-making process while managing the system.

- Implementing clean solutions to environmental problems.
- Environmental improvement will improve the life of citizens.

## RECOMMENDED PRODUCTS

- MTX-4G-JAVA-IOT: Modular and programmable modem
- CERVELLO: IoT Platform

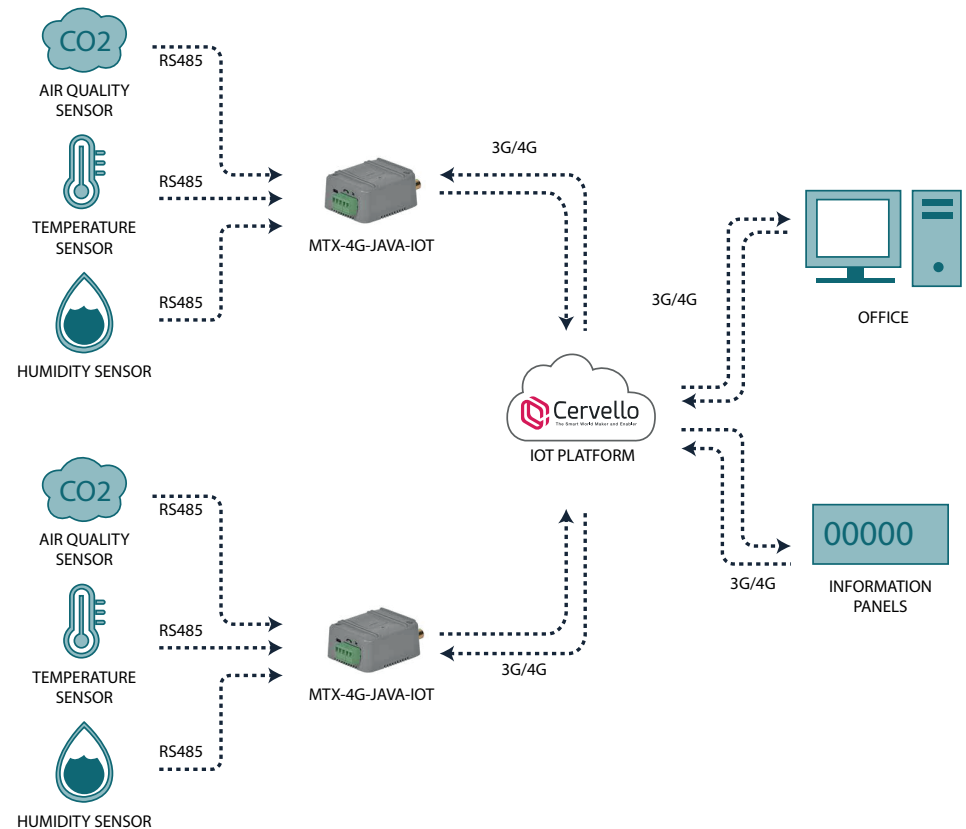

# 9. ENVIRONMENT & AIR QUALITY - EQUIPMENT



## MTX-4G-JAVA-IOT

*Modem 4G Java Internet of Things*

MTX-JAVA-IoT is an innovative and powerful all-in-one solution for the most demanding IoT applications, allowing the high-speed transmission of cellular data via 2G (GPRS), 4G (LTE Cat. 1), voice GSM and SMS. It is a device programmable in Java with a complete set of interfaces (RS232, RS485, USB, I2C, IOs optoisolated and analog-digital converter). It is built in modules, which allows optional characteristics as GPS, RF card, internal battery, Ultra Low Power, relays or analog audio.

## MECHANICAL SPECIFICATIONS

- DC INPUT: 24V (7 a 50VDC)
- TEMPERATURE RANGE: -30°C a +85°C
- DIMENSIONS: 78.1 x 66.8 x 37.2mm
- WEIGHT: 190gr

## GENERAL FEATURES

- SIM application toolkit, 3GPP release 99
- Control and TCP/IP stacks access via AT commands
- Internet services: TCP, UDP, HTTP, FTP, SMTP, POP3
- Optional Internal 1650mAh Li-Po battery
- Optional 3-axis accelerometer
- Operating status LEDs

## INTERFACES

- GSM FME M (3G) and SMA F (4G) antenna connector or other RF
- SIM card interface 1.8V and 3V
- DB9 female connector
- HD-DB15 female connector: RS232 (4-wire), 3x inputs (2x opto), 2x opto outputs, 2x analog inputs
- 5-way plug-in: RS485, power supply input; 7-way plug-in: latch relay; 5-way plug-in: 200VAC/6A relay
- 2x RJ11 connectors



# 10. SMART TRANSPORTATION

Demographic forecasts calculate the urban population will increase by 25 billion in the next decades. To face this challenge, an effective public transportation network is key for the good functioning of any city.

On one hand we have one MTX-Router-Helios II device installed in each bus. This router is able to receive information (next bus stops, timing and location of the bus, entertainment, advertising, news casts, etc.) and to send it to the information panels (via Ethernet). The MTX-Router-Helios II also receives information from a security camera (via Ethernet) and a driver's panic button. The router is also able to supply the bus with WiFi connectivity, and to send location information from its internal GPS to Cervello Device Manager. A 3G/4G connection with Cervello allows real time data transmission, which can be accessed from the central offices, from where we can manage all the information, including the content we send to the information panels and to an app where users can also have access to relevant information.

On the other hand we have another router installed in each bus stop, so it can supply the stop with WiFi connectivity and send relevant information from Cervello (via 3G/4G) to the information panel (via Ethernet) on each stop.

Some of the benefits of Smart Transportation are:

- Better customer experience thanks to real time access to information of buses timing, WiFi access, etc.
- Fleet management improvement thanks to real time access to GPS information.
- Improved security thanks to camera.

## RECOMMENDED PRODUCTS

- MTX-ROUTER-HELIOS II: Industrial 4G WiFi 4xEthernet Router
- CERVELLO: IoT Platform

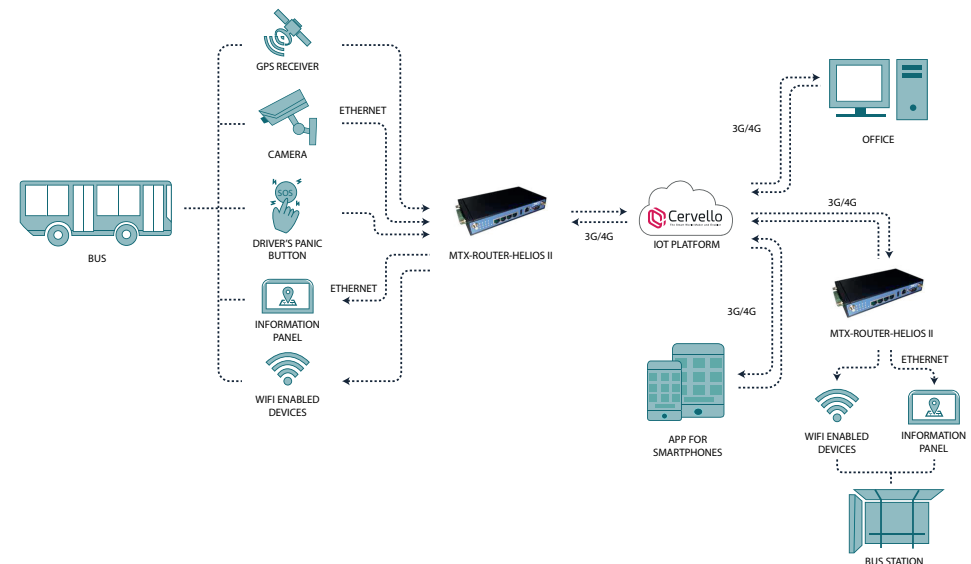

# 10. SMART TRANSPORTATION - EQUIPMENT



## MTX-ROUTER-HELIOS II

*Industrial 4G WIFI 4xEthernet Router*

MTX-Router-Helios II is a new LTE router developed for industrial applications. It has special features that make this device the perfect solution for harsh environments such as in-vehicle use, factories, traffic information panels, wind and solar farms...

### MECHANICAL SPECIFICATIONS

- DC INPUT: 12V (9Vdc a 48Vdc)
- TEMPERATURE RANGE: -20°C to +70°C
- DIMENSIONS: 187 x 110 x 31mm
- WEIGHT: 600g

### GENERAL FEATURES

- 4G supervisor to maintain connection always active
- DHCP server

- NAT/IP firewall
- Modbus TCP to Modbus RTU
- Serial tunnelling
- DynDNS, NoIP
- Programmable autoreset

### INTERFACES

- 4x ethernet 10/100 BaseT (RJ45 connector)
- Internal WiFi 802.11 b/g/n optional
- USB, 1x RS232 4-wire and RS485/2322-wire
- 2x digital input/output
- Operating LEDs
- Dual SIM card interface 1.8V/3V
- Console port connector
- 5x SMA antenna connectors
- Terminal block for power redundant power input

# 11. SMART CITY WITH CERVELLO & MTX

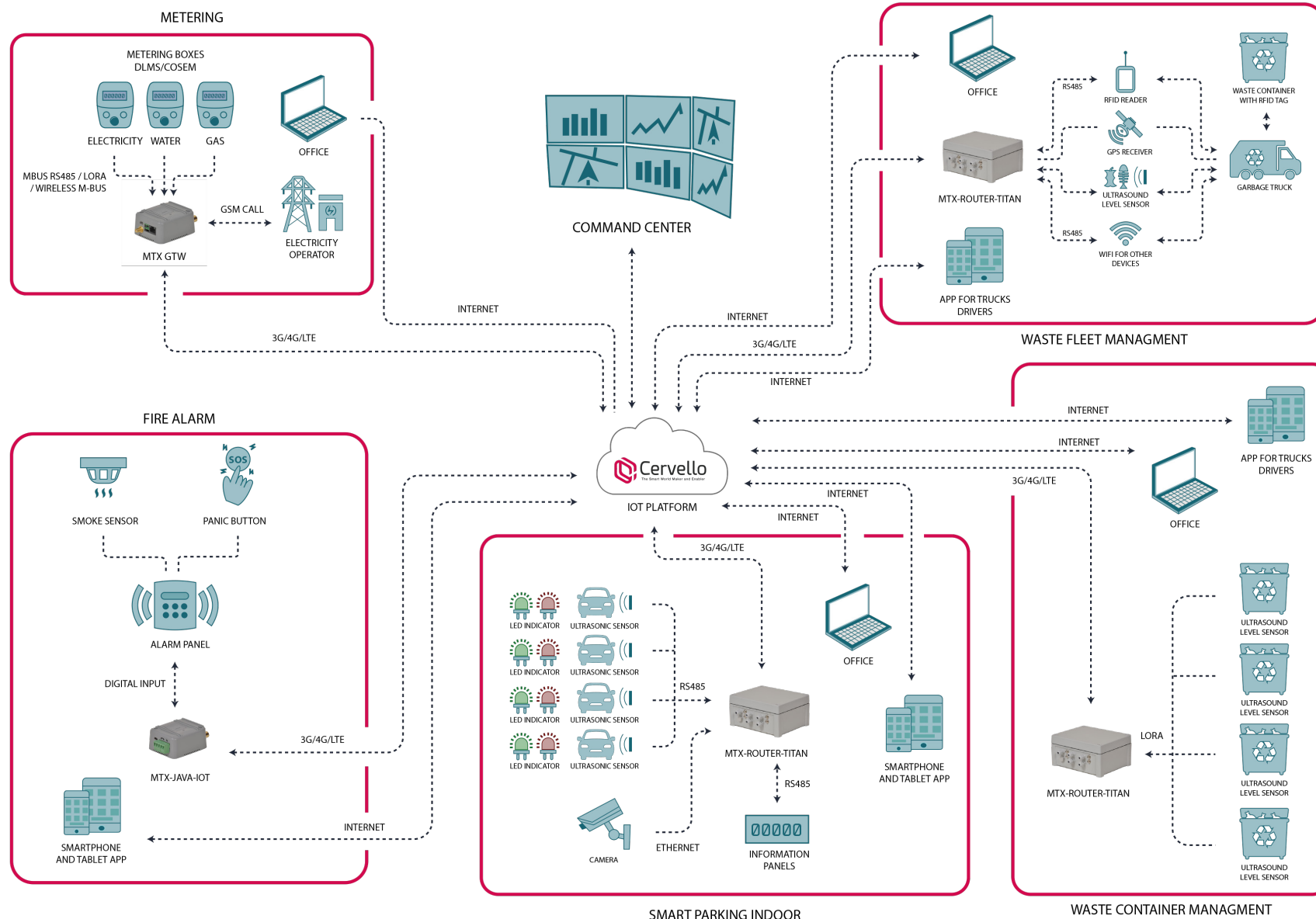



# flexitron group



## CONTACT US

Alejandro Sánchez 109, 28019 Madrid (SPAIN)

Tel +34.91.560.27.37

Fax +34.91.565.28.65

[www.matrix.es](http://www.matrix.es) - [www.mtxm2m.com](http://www.mtxm2m.com) - [www.iotblue.net](http://www.iotblue.net) - [www.taxitronic.com](http://www.taxitronic.com)